

1 ALL COMPONENTS

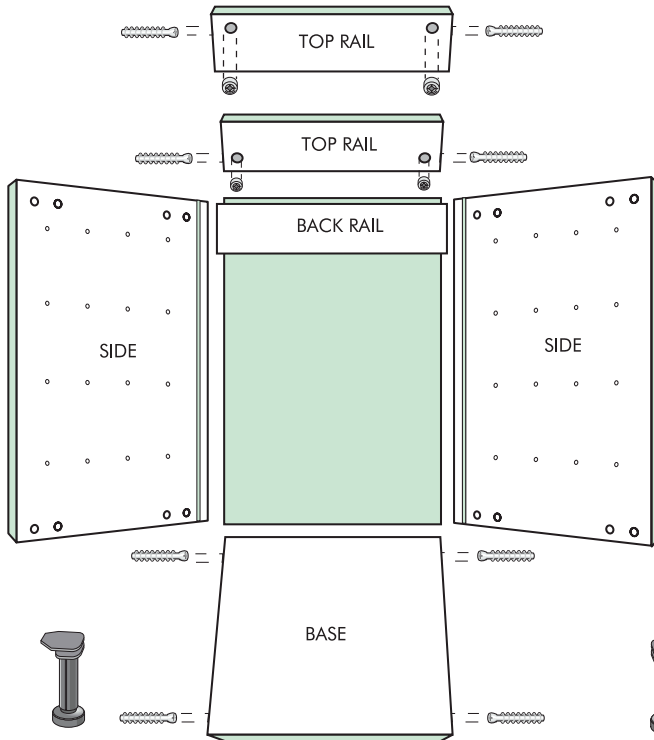

USING THE CAM SYSTEM



INSERT THE CAM SCREW INTO THE SIDES SO THAT IT PROTRUDES ENOUGH FOR THE HEAD OF THE SCREW TO BE ROUGHLY CENTRED IN THE CAM HOLES IN THE BASE



START WITH THE TRIANGLE POINTING TO THE SIDE PIECE

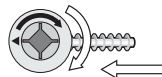

TURN A HALF ROTATION SO THAT THE TRIANGLE POINTS TO THE INSIDE OF THE CABINET

2 START BY ADDING THE RUNNERS TO THE RIGHT AND LEFT SIDES

SCREW THE RUNNERS TO THE LEFT AND RIGHT HAND SIDES USING THE PRE-DRILLED HOLES. RUNNERS SHOULD SIT ALMOST FLUSH WITH THE FRONT OF THE CUPBOARD

TAKE NOTE THE RUNNER WHEEL ON EACH RUNNER SHOULD BE FACING DOWN

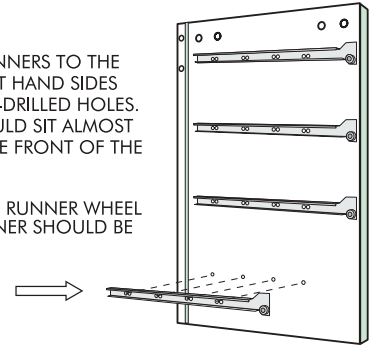

3 NOW ADD THE BOTTOM TO THE RIGHT SIDE

INSERT THE CAMS IN THE PRE-DRILLED HOLES IN THE BOTTOM AND RIGHT SIDE PANELS

THE CAM FOR THE BOTTOM SHELF IS TIGHTENED FROM BENEATH

INSERT THE DOWELS IN THE PRE-DRILLED HOLES AFTER APPLYING A LITTLE COLD GLUE INTO THE DOWEL HOLES

BRING TOGETHER AND TIGHTEN THE CAMS.

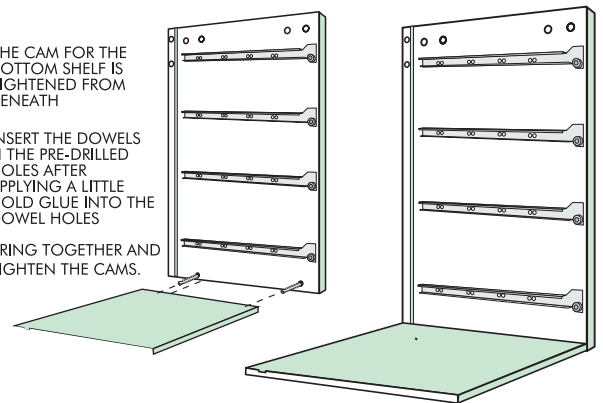

4 NOW JOIN THE TOP & BACK PANELS TO THE RIGHT SIDE

INSERT THE CAM IN THE PRE-DRILLED HOLES IN THE TOP AND BACK CLEAT AND INTO THE RIGHT SIDE TIGHTEN THE BACK CLEAT FROM THE REAR. TIGHTEN THE TOP PANELS FROM BELOW

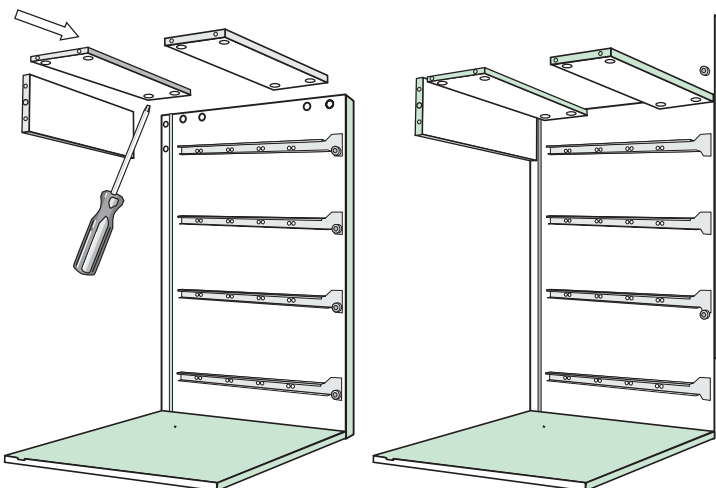

5 FIX THE OTHER SIDE

FIX THE REMAINING SIDE INTO PLACE

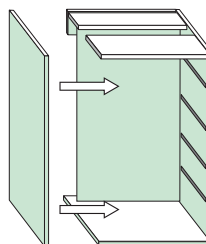

6 SLIDE IN THE BACKING BOARD

SLIDE THE BACKING BOARD INTO THE GROOVE

NB USING 8 X 30 SCREWS SECURE THE BACKING

USING 8 X 30 SCREWS LOCK THE CAMS FROM THE SIDE OF THE UNIT

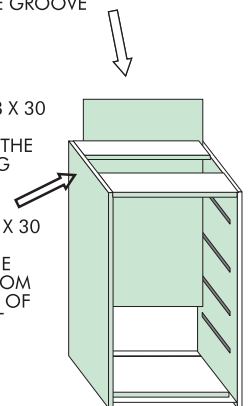

7

FLIP IT OVER AND ADD THE LEGS

A FLIP THE CABINET UPSIDE DOWN

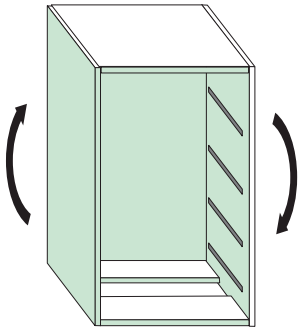

B PLACE THE LEGS 16MM AWAY FROM THE EDGE OF THE UNIT WITH THE TAB FACING OUT AND SCREW DOWN

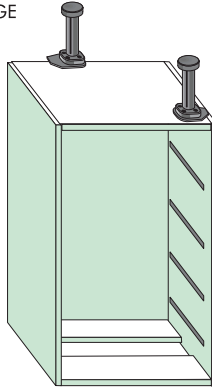

C ADJUST THE HEIGHT OF THE LEGS AND FLIP IT RIGHT WAY UP AGAIN

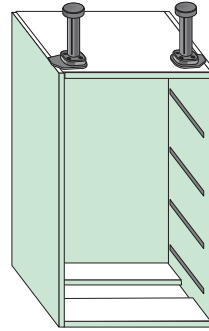

D NOW YOU NEED TO ADD THE DRAWERS

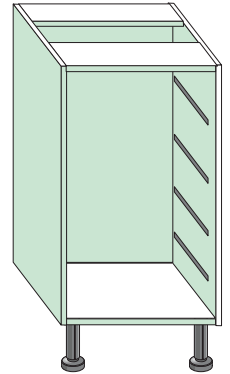

8

DRAWER ASSEMBLY

A SLIDE THE DRAW BASE INTO POSITION FROM THE FRONT SCREW IN POSITION FROM BELOW. TIP: DRILL A 2mm PILOT HOLE TO ALLOW THE SELF TAPPING SCREWS EASY PURCHASE WHEN ASSEMBLING THE DRAWER BOTTOM AND BACK.

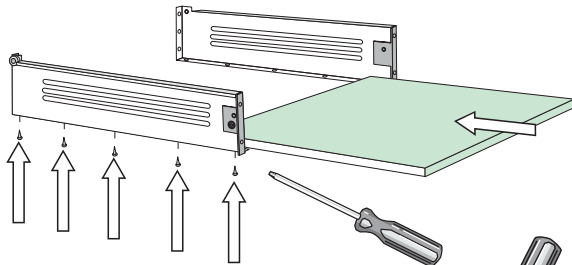

B SCREW THE BACKING BOARD TO THE METAL BOX DRAWER SIDES FROM THE BACK.

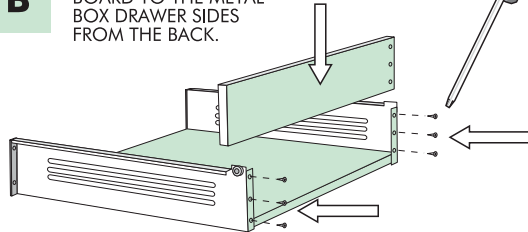

C COMPLETED DRAWER

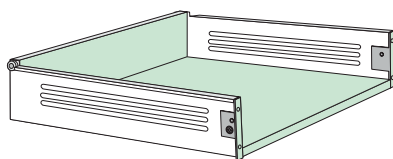

9

NOW INSERT THE DRAWERS

TO INSERT THE DRAWERS TILT THE DRAWERS AT A SLIGHT ANGLE AND FEEL THE RUNNER WHEEL GAIN TRACTION AND PUSH TOWARDS THE BACK.

YOUR FINISHED DRAWER CABINET CAN BE ALIGNED WITH OTHERS TO COMPLETE YOUR KITCHEN.

DRAWER FRONTS AND, COUNTER TOPS CAN BE ADDED AS YOU NEED.

